

Elinco International JPC

Precision Rotating Components

- Connecticut Motor and Air Moving Device Manufacture. State of the Art High Tech Factory.
- Acquired GE SELSYN motor line, Inertial motor product line, Philips Airpax motor line. Licensed various technology to Kollmorgen and Electrocraft.
- **50+ year partnership with Nidec Corp.** *Nidec* \$300M division and \$1B division (recent addition).
- Manufacturing expansion started 2010. Advanced Slotless Brushless Motor Technology and Actuation Systems.
- New Product Introduction and manufacturing in the US, China, and Vietnam.

SUPERIOR QUALITY SINCE 1926



Located at the Fairfield Metro a 1.1 mil sq./ft. commercial development and regional commuter rail station on the New York City metro rail line (1 hour from Manhattan).



Elinco - Corp. facility, exterior view.



Elinco Factory Fairfield, CT.



Elinco factory floor in Asia.

Elinco Corporate Office and Factories

Elinco Research and Development
Engineering Department and
Product Overview



 **Elinco International JPC**
Precision Rotating Components



Markets and Applications



VFD blade control
Wind
Turbine



Water Generation
from solar panels

Energy + Water



Hydrogen Fueling Stations

Data

Hardware innovation coming
with data rates 100 times faster



Data Transmission
through Fiber



Security Badge Reader



Data Center Cooling



Switching Equipment



Medivac Drone



Autonomous and Manned
Underwater Vehicles

Military/ Aerospace

Mil-Aero innovation

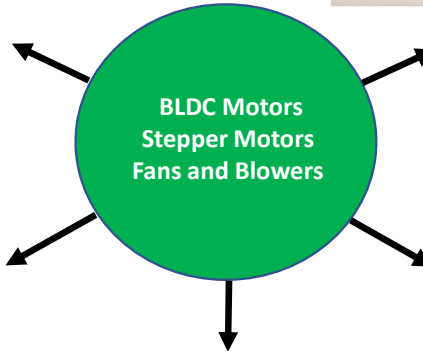

CT Scan Machine
International Top 2 or 3



Infusion Pump

Medical + Diagnostics



Genomic and Blood
Diagnostics



Pump for MRI



Surgical Tools

Industrial + Automation



Automated Bagger



Train Cab cooling



Industrial Tools

Products

Major product group & Application



Fans & Blowers

DC Fan, AC Fan, DC Blower, Assemblies

For cooling, exhaust, suction, and air circulation applications
Cell Phone Base Station, Router, Server, Power Unit, OA Equipment,
Car, Home Appliance, House/Building Equipment, Textile Machinery



Stepping Motors

Motor Circuit Integ. Motor Motor & Circuit Board

For the cases that high-speed response
and position accuracy are required
OA Equipment, Semi Conductor Manufacturing, Monetary Equipment
Surveillance Camera, Lighting, Construction Machinery



Brushless DC Motors

AC/DC Motor Motor & Circuit Board

For applications that require high efficiency and long life
Commercial Refrigerator, OA Equipment, Monetary Equipment, Bath
Ventilation, Industrial Drone, Medical Equipment,
Measuring Equipment, Working Machine, Home Appliance



DC Motors

Motor & Gear Head, Assemblies

For applications that require high efficiency / controllability
OA Equipment, Amusement Equipment, Working Machine, Banking
Machine, Agricultural Machinery, Medicine Dispensing Machine, Car,
Vending Machine, Home Appliance, Medical Equipment, Test Equipment



System & Ice maker

Ice Maker, Medical Equipment, Medical Blood Pump

For special applications / custom products
Ice Maker for Refrigerator, Medical Equipment, Test Equipment, Agricultural
Machinery, Home/Building Equipment,
Industrial Machinery



AC Motors & GH

Induction & Gear Head Shaded-pool Motors, Synchronous Motor

For applications that a constant speed rotation
/ stop system is required
Working Machine, Home/Building Equipment, Banking Machine, Agricultural
Machinery, Medicine Dispensing Equipment, Home Appliance, Measuring
Equipment, Food Processing Machinery



Sensors

Slip Ring, Potentiometer

For motors that require special applications / controls
Surveillance Camera, Semi Conductor Manufacturing Machine,
Printing Machine, Construction Machinery, Lighting Equipment, OA Equipment,
Test Equipment

Slotless Brushless DC motors

Slotless BLDC SL Series



Product Features

- Zero cogging torque
- Smooth torque
- High speed performance
- Low noise levels
- High efficiency
- Easier cooling
- Smaller envelope

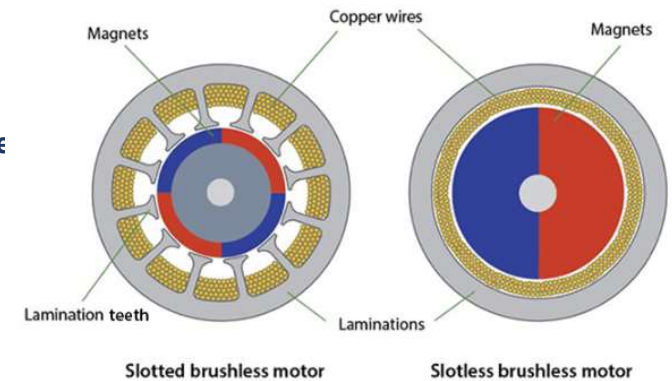

Applications:

Industries & Applications for Elinco SBLDC Technology

- Medical
- Industrial hand tools
- Lasers, Riveting,
- UAVs, Aerospace & Defense

**Contract manufacturing overseas*

Design and Manufacturing completed in-house at Elinco's Fairfield, CT Facility*



Elinco International JPC

Slotless Brushless DC motors

Slotless BLDC High Energy Series



Worldwide Patented Winding Process

- Performance improvement over Full Automation – less tooling costs
- Better torque due to higher achievable fill and new high-density metals

Comparison of Gen 1 Hand wound with Bobbin VS Gen 2 Bobbin-less Semi-automated patented process.

% Drop in Resistance

| Housed Size | 16mm DC | 30mm | | 35mm | 40mm | | 48mm | 48mm | |
|-------------------------------|----------|----------|---------|----------|---------|----------|---------|----------|---------|
| Voltage Range | 12V-360V | 12V-360V | | 12V-360V | | 12V-360V | | 12V-360V | |
| Operating Voltage | 20V DC | 20V DC | 320V DC | 20V DC | 320V DC | 20V DC | 320V DC | 20V DC | 320V DC |
| BEMF @ 1800RPM | 2.3 | 2.85 | 25.05 | 25.15 | 3.52 | 24.12 | 23.87 | 9.47 | 27.31 |
| Resistance LL | 1.6 | 0.122 | 11.39 | 5.99 | 0.045 | 1.51 | 1.56 | 0.078 | 0.881 |
| Inductance LL | 0.5 | 0.051 | 4.71 | 2.65 | 0.035 | 1.53 | 1.54 | 0.088 | 0.61 |
| HE* estimated values | | | | | | | | | |
| BEMF @ 1800RPM | 2.2 | 2.85 | 25.33 | 24.53 | 3.626 | 24 | 24 | 9.89 | 27.31 |
| Resistance LL | 1.45 | 0.084 | 5.8 | 3.87 | 0.025 | 1.36 | 1.36 | 0.053 | 0.798 |
| % drop in resistance from STD | -37.16 | -31.15% | -49.08% | -35.39% | -44.44% | -9.93% | -12.82% | -32.05% | -9.42% |

- Smaller package by use of higher energy materials
- Magnet retention:
 - Embedded magnets for simple manufacturing, elimination of the need for a rotor speed, improved part to part rotor balance consistency
 - Surface mount magnet for the design that need that little bit extra
- Product can be sold as framed, frameless, or integrated into a custom housing of the customers' design.
- Magnetic designs optimized for the criteria that make our customers successful.

Power density

Noise

Weight

Cost

Vibration

Efficiency

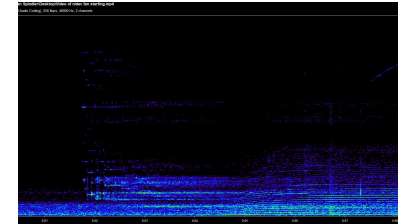

Brushless DC motors



Coreless Motors

Brushed & Brushless Options Available

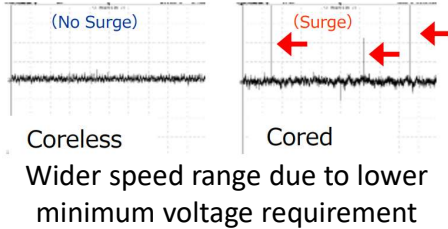

Motor and Gearhead are preassembled as a single part number

★ENGINE

- Cored**
Small
Low cost
- Coreless**
High Torque
Hi speed
- STM**
High resolution
Small



★GEAR

- Spur**
Standard
- Worm**
Silent
- 2step worm**
Space saving
- Planetary**
Durable



★SENSOR

- ★ENCODER
- ★PI
- ★GMR

★OPTION

- ★FPC
- ★Torque limiter
- ★Control circuit



| Size | φ 3.5 | φ 4 | φ 6 | φ 8 | φ 10 | φ 12 | φ 14 | φ 16 | φ 20 | φ 22 | φ 24 | φ 25 | φ 29 | φ 30 | φ 32 | φ 35 | φ 37 |
|------|-------|------|------|------|------|------|------|------|------|------|------|------|------|------|------|------|------|
| NAMC | | | | | | | | | | | | NAMC | NAMC | | | NAMC | NAMC |
| NPCJ | NPCJ | NPCJ | NPCJ | NPCJ | NPCJ | NPCJ | NPCJ | NPCJ | NPCJ | NPCJ | NPCJ | NPCJ | | NPCJ | NPCJ | | |

Brushless DC motors

Coreless Motors



4-6 Structure Motor

**6 Slot Core
4 Pole Magnet**

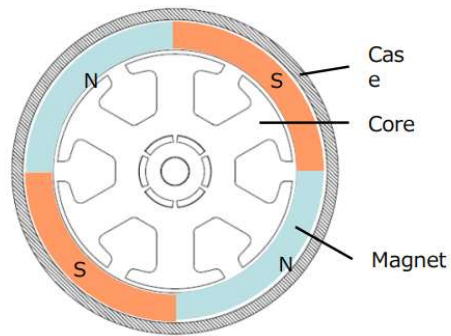

Normal Motor

**3 Slot Core
2 Pole Magnet**

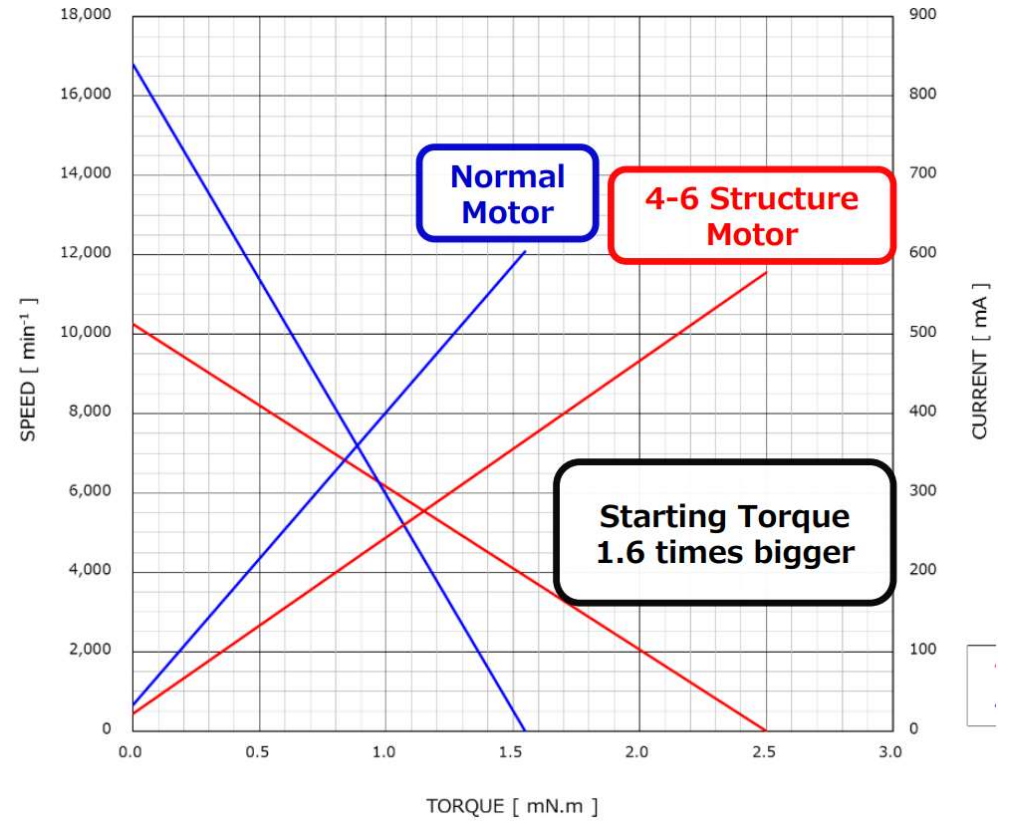
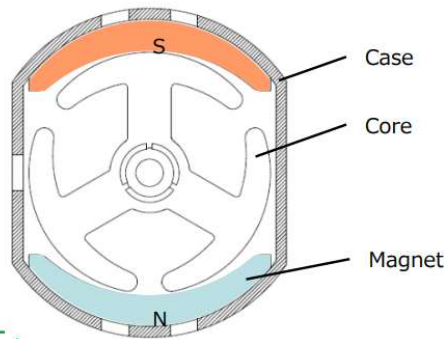

Inner and Outer Rotor Brushless DC

High-efficient, long-life, wide-speed-control motors

- Lower inertia and dissipation of heat losses
- Few friction components to achieve a better durability than brushed DC motors
- Gearbox options.



Applications:

AGV's, agriculture, measuring instruments, textiles, industrial, electric tools, medical equipment, office, energy, home, office.

| Item # | Motor Frame Size | Number of Poles | Rated Voltage | Rated Torque | Rated Speed | Rated Power | Peak Current |
|----------------|------------------|-----------------|---------------|--------------|-------------|-------------|--------------|
| VH22S4504-24 | 22 x 45 mm | 8 | 24 V | 8 mN·m | 4600 rpm | 4 W | 0.04 |
| VH22S45-24 | 24 x 45 mm | 8 | 24 V | 9.6 mN·m | 4600 rpm | 3.8 W | 1.1 A |
| VH22S6808-24 | 22 x 68 mm | 8 | 24 V | 20 mN·m | 3800 rpm | 8 W | 1.5 A |
| VH22S70-24 | 22 x 70 mm | 8 | 24 V | 24 mN·m | 3500 rpm | 8 W | 1.5 A |
| VH28S2604-15 | 28 x 26 mm | 4 | 15 V | 7 mN·m | 8000 rpm | 6 W | 2.5 A |
| VH28S3815-15 | 28 x 38 mm | 4 | 24 V | 14.12 mN·m | 10000 rpm | 14.78 W | 2.8 A |
| VH28S7716-24 | 28 x 77 mm | 4 | 24 V | 50 mN·m | 3700 rpm | 15 W | 0.13 |
| VH33S3807-24 | 33 x 38 mm | 4 | 24 V | 22 mN·m | 3000 rpm | 7 W | 1.7 A |
| VH33S8040-48 | 33 x 80 mm | 4 | 48 V | 40 mN·m | 10000 rpm | 40 W | 0.13 |
| VH33S8040-24 | 33 x 80 mm | 4 | 24 V | 50 mN·m | 7800 rpm | 40 W | 4.8 A |
| VH36S3008-24 | 36 x 30 mm | 8 | 24 V | 15 mN·m | 4800 rpm | 8 W | 1.5 A |
| VH36S4018-24 | 36 x 40 mm | 8 | 24 V | 35 mN·m | 4800 rpm | 18 W | 0.13 |
| VH36S4018-24-1 | 36 x 40 mm | 8 | 24 V | 36 mN·m | 4800 rpm | 18 W | 0.17 |
| VH36S5524-24 | 36 x 55 mm | 8 | 24 V | 50 mN·m | 4500 rpm | 24 W | 0.17 |
| VH36S5733-24 | 36 x 57 mm | 8 | 24 V | 70 mN·m | 4500 rpm | 33 W | 5.3 A |
| VH36S6040-24 | 36 x 60 mm | 8 | 24 V | 80 mN·m | 4800 rpm | 40 W | 6.5 A |
| VH39S4840-24 | 39 x 48 mm | 6 | 24 V | 110 mN·m | 3200 rpm | 40 W | 0.25 |

Brushless DC motors

Slotted Brushless DC

| Item # | Motor Frame Size | Number of Poles | Rated Voltage | Rated Torque | Rated Speed | Rated Power | Peak Current |
|----------------|------------------|-----------------|---------------|--------------|-------------|-------------|--------------|
| VH42S4022-24 | 42 x 40 mm | 10 | 24 V | 70 mN·m | 3000 rpm | 22 W | 0.17 |
| VH42S4026-24 | 42 x 40 mm | 8 | 24 V | 63 mN·m | 4000 rpm | 26 W | 0.25 |
| VH42S4020-24 | 42 x 40 mm | 6 | 24 V | 64 mN·m | 3000 rpm | 20 W | 3.5 A |
| VH42S6054-24 | 42 x 60 mm | 6 | 24 V | 178 mN·m | 3000 rpm | 53.5 W | 0.38 |
| VH42S6041-15 | 42 x 60 mm | 4 | 15 V | 88 mN·m | 4450 rpm | 41 W | 0.46 |
| VH42S6053-24 | 42 x 60 mm | 8 | 24 V | 125 mN·m | 4000 rpm | 52.5 W | 10.8 A |
| VH42S6025-24 | 42 x 60 mm | 8 | 24 V | 56 mN·m | 4200 rpm | 25 W | 4.4 A |
| VH42S6043-24 | 42 x 60 mm | 4 | 24 V | 68 mN·m | 5900 rpm | 43 W | 6.6 A |
| VH42S6050-24 | 42 x 60 mm | 10 | 24 V | 160 mN·m | 3000 rpm | 50 W | 8.3 A |
| VH42S8081-24 | 42 x 80 mm | 10 | 24 V | 260 mN·m | 3000 rpm | 81 W | 13.5 A |
| VH42S8094-24 | 42 x 80 mm | 6 | 24 V | 300 mN·m | 3000 rpm | 94 W | 14.5 A |
| VH42S8078-24 | 42 x 80 mm | 8 | 24 V | 185 mN·m | 4000 rpm | 77.5 W | 15.5 A |
| VH42S8562-24 | 42 x 85 mm | 8 | 24 V | 150 mN·m | 4000 rpm | 62 W | 11.4 A |
| VH42S9376-24 | 42 x 93 mm | 8 | 24 V | 115 mN·m | 6300 rpm | 76 W | 11.8 A |
| VH42S100113-24 | 42 x 100 mm | 10 | 24 V | 360 mN·m | 3000 rpm | 113 W | 19 A |
| VH42S100135-24 | 42 x 100 mm | 6 | 24 V | 430 mN·m | 3000 rpm | 135 W | 20.8 A |
| VH42S100105-24 | 42 x 100 mm | 8 | 24 V | 250 mN·m | 4000 rpm | 105 W | 21.7 A |
| VH52S86100-24 | 52 x 86 mm | 4 | 24 V | 240 mN·m | 4000 rpm | 100 W | 15.5 A |
| VH52S8624-12 | 52 x 86 mm | 4 | 12 V | 160 mN·m | 1500 rpm | 24 W | 8.5 A |
| VH57S4423-36 | 57 x 44 mm | 4 | 36 V | 55 mN·m | 4000 rpm | 23 W | 0.17 |
| VH57S45-36 | 57 x 45 mm | 4 | 36 V | 55 mN·m | 4000 rpm | 23 W | 0.17 |
| VH57S5446-36 | 57 x 54 mm | 4 | 36 V | 110 mN·m | 4000 rpm | 46 W | 6.8 A |
| VH57S5483-36 | 57 x 54 mm | 6 | 36 V | 200 mN·m | 4000 rpm | 83 W | 8.6 A |
| VH57S55-36 | 57 x 55 mm | 4 | 36 V | 110 mN·m | 4000 rpm | 46 W | 0.29 |
| VH57S7499-36 | 57 x 74 mm | 4 | 36 V | 220 mN·m | 4000 rpm | 92 W | 11.5 A |
| VH57S74167-36 | 57 x 74 mm | 6 | 36 V | 400 mN·m | 4000 rpm | 167 W | 16 A |
| VH57S75-36 | 57 x 75 mm | 4 | 36 V | 220 mN·m | 4000 rpm | 92 W | 0.00 |
| VH57S7694-36 | 57 x 76 mm | 8 | 36 V | 300 mN·m | 3000 rpm | 94 W | 12.3 A |
| VH57S7694-36 | 57 x 76 mm | 8 | 36 V | 450 mN·m | 3000 rpm | 141 W | 18.2 A |
| VH57S94138-36 | 57 x 94 mm | 4 | 36 V | 320 mN·m | 4000 rpm | 133 W | 16.5 A |
| VH57S94251-36 | 57 x 94 mm | 6 | 36 V | 600 mN·m | 4000 rpm | 251 W | 29 A |
| VH57S95-36 | 57 x 95 mm | 4 | 36 V | 320 mN·m | 4000 rpm | 133 W | 17 A |
| VH57S96141-36 | 57 x 96 mm | 8 | 36 V | 450 mN·m | 3000 rpm | 141 W | 18.2 A |
| VH57S114335-36 | 57 x 114 mm | 6 | 36 V | 800 mN·m | 4000 rpm | 335 W | 35 A |
| VH57S115-36 | 57 x 115 mm | 4 | 36 V | 430 mN·m | 4000 rpm | 180 W | 21 A |
| VH57S116188-36 | 57 x 116 mm | 8 | 36 V | 600 mN·m | 3000 rpm | 188 W | 23.8 A |

| Item # | Motor Frame Size | Number of Poles | Rated Voltage | Rated Torque | Rated Speed | Rated Power | Peak Current |
|------------------|------------------|-----------------|---------------|--------------|-------------|-------------|--------------|
| VH60S80110-150 | 60 x 80 mm | 4 | 150 V | 350 mN·m | 3000 rpm | 110 W | 0.13 |
| VH60S95750-150 | 60 x 95 mm | 4 | 150 V | 500 mN·m | 14000 rpm | 750 W | 17 A |
| VH60S1501500-310 | 60 x 150 mm | 4 | 310 V | 1200 mN·m | 12000 rpm | 1500 W | 17.5 A |
| VH86S56110-48 | 86 x 56 mm | 8 | 48 V | 350 mN·m | 3000 rpm | 110 W | 9.5 A |
| VH86S64130-48 | 86 x 64 mm | 8 | 48 V | 400 mN·m | 3000 rpm | 130 W | 0.46 |
| VH86S70220-48 | 86 x 70 mm | 8 | 48 V | 700 mN·m | 3000 rpm | 220 W | 20 A |
| VH86S77250-48 | 86 x 77 mm | 8 | 48 V | 400 mN·m | 3000 rpm | 130 W | 0.46 |
| VH80S84280-48 | 80 x 84 mm | 8 | 48 V | 900 mN·m | 3000 rpm | 280 W | 22 A |
| VH86S84330-48 | 86 x 84 mm | 8 | 48 V | 1050 mN·m | 3000 rpm | 330 W | 24 A |
| VH86S96440-48 | 86 x 96 mm | 8 | 48 V | 1400 mN·m | 3000 rpm | 440 W | 33 A |
| VH80S105530-48 | 80 x 105 mm | 8 | 48 V | 1700 mN·m | 3000 rpm | 530 W | 45 A |
| VH86S105500-48 | 86 x 105 mm | 8 | 48 V | 1600 mN·m | 3000 rpm | 500 W | 37 A |
| VH80S120700-48 | 80 x 120 mm | 8 | 48 V | 2200 mN·m | 3000 rpm | 700 W | 22 A |
| VH86S123660-48 | 86 x 123 mm | 8 | 48 V | 2100 mN·m | 3000 rpm | 660 W | 56 A |
| VH86S125700-48 | 86 x 125 mm | 8 | 48 V | 2200 mN·m | 3000 rpm | 700 W | 52 A |
| VH80S140950-48 | 80 x 140 mm | 8 | 48 V | 3000 mN·m | 3000 rpm | 950 W | 78 A |
| VH90S80220-115 | 90 x 80 mm | 4 | 115 V | 400 mN·m | 5300 rpm | 220 W | 8.5 A |
| VH110S102942-60 | 110 x 51 mm | 8 | 60 V | 4500 mN·m | 3000 rpm | 1413 W | 110 A |
| VH110S102942-60 | 110 x 51 mm | 8 | 60 V | 3000 mN·m | 3000 rpm | 942 W | 68 A |
| VH125S64340-24 | 125 x 60 mm | 24 | 60 V | 6800 mN·m | 480 rpm | 340 W | 46 A |
| VH150S3255-24 | 150 x 32 mm | 28 | 24 V | 1000 mN·m | 500 rpm | 55 W | 0.42 |
| VH150S3655-24 | 150 x 36 mm | 28 | 24 V | 1800 mN·m | 300 rpm | 55 W | 0.46 |
| VH150S46140-48 | 150 x 46 mm | 28 | 48 V | 3600 mN·m | 350 rpm | 140 W | 13 A |

Brushless DC motors

Outer Rotor BLDC

Inner Rotor BLDC



Applications:

Office equipment, money-handling machines, industrial drones, medical equipment, measuring instruments, working machines, appliances, electric tools, automatic doors, kitchen appliances, transfer units, etc.

High-efficient, long-life, wide-speed-control motors

- Proper rotor-detecting energization to achieve high efficiency and energy-saving capability
- Few friction components to achieve a better durability than brushed DC motors
- A dedicated control circuit to control speed widely and accurately.
- Compatible with our company's induction motors (installation).

| 機種名 | | 適合ドライバ | 出力 W | 電源電圧 V(DC) | 速度制御範囲 r/min | 定格トルク mN·m |
|-------------|--------------|---------------------|---------|---------------|-----------------|---------------|
| (ストレート軸) | (ピニオン軸) | | | | | |
| FED6P10S-D3 | FED6P10PF-D3 | (ドライバセット販売) | 10 | 24 | 200~2500 | 64 |
| FED6P20S-D3 | FED6P20PF-D3 | (ドライバセット販売) | 20 | 24 | 200~2500 | 130 |
| FHD6P20S-D3 | FHD6P20PF-D3 | (ドライバセット販売) | 20 | 24 | 200~2500 | 98 |
| FHD6P40S-D3 | FHD6P40PE-D3 | (ドライバセット販売) | 40 | 24 | 200~2500 | 200 |
| FH6S20H-D3 | FH6PF20H-D3 | FHD620HD3 | 20 | 24 | 200~2500 | 98 |
| FH6S40H-D3 | FH6PE40H-D3 | FHD640HD3 | 40 | 24 | 200~2500 | 200 |
| FY6S6-D3 | FY6PF6N-D3 | FYD66PD3/FYD66SD3 | 6 | 24 | 200~2500 | 39 |
| FY8S15-D3 | FY8PF15N-D3 | FYD815PD3/FYD815SD3 | 15 | 24 | 200~2500 | 98 |
| FY8S25-D3 | FY8PF25N-D3 | FYD825PD3/FYD825HD3 | 25 | 24 | 200~2300 | 157 |
| FY9S40-D3 | FY9PF40N-D3 | FYD940PD3/FYD940HD3 | 40 | 24 | 200~2000 | 250 |

Brushless DC motors



6, 15, 20, 25, 40 W motors available in Nidec Catalog
39 ~ 290 mN-m Rated Torque
NEMA 24 ~ 32 Frame Size
Hall Effect Sensor feedback

Higher/Lower Power and NEMA sizes available with different Elinco offerings

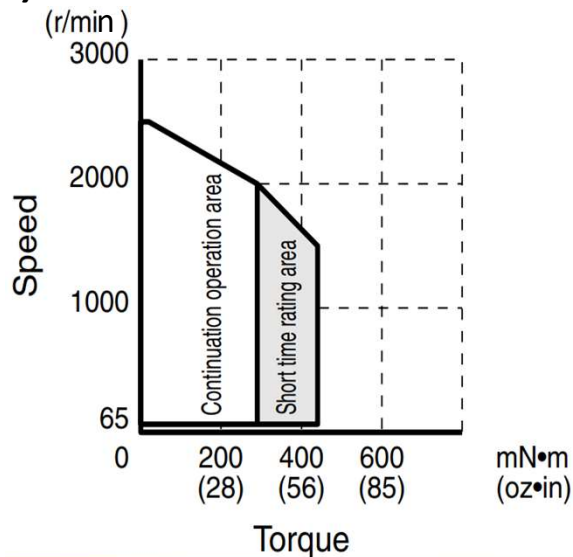

Features Compared to Brushed

- Flat Rated Torque
- Closed-Loop Feedback
- Longer Life, no maintenance
- Less Audible and Electrical Noise
- More Efficient and Powerful

Sizing Considerations

- Operational Torque
- Operational Speed Range
- Starting Acceleration (Starting Torque)
- Inertial Loading
- Gearbox Sizing

Gearbox Torque

$$\text{Output Torque} = \eta \cdot GR \cdot \tau$$

η = Gearbox Efficiency

GR = Gear Ratio

τ = Motor Torque

Stepper motors



Fast response, high-precision, and high controllability

- HB-type stepping motors that follow input pulses to rotate by a certain angle each time
- An open loop can be used to control locations and rotating angles.
- Super-slow synchronized operations are possible even without the use of a reducer
- Applications vary, from printers to copiers to factory automation equipment.
- Ultra low vibration and noise

Applications:

Office machines, semiconductor production equipment, money-handling machines, surveillance cameras, lighting equipment, construction equipment, medical devices, physical and chemical science devices, play game machines, spinners, etc.

| シリーズ名 | 相数 | 取付寸法 mm | ステップ 角°/step | 駆動方式 | 最大静止トルク mN · m | 特徴 |
|-----------|----|------------|-----------------|-------------|-----------------------|----------|
| KV28 | 2 | □28 | 1.8 | ユニポーラ/バイポーラ | 65~120 / 85~165 | ダウンサイズ |
| KH39 800 | 2 | □39 | 1.8 | ユニポーラ/バイポーラ | 59~127 / 78~157 | 低振動 |
| KH42 B900 | 2 | □42 | 1.8 | ユニポーラ/バイポーラ | 190~460 / 250~570 | 低振動 |
| | | | 4.09 | ユニポーラ/バイポーラ | 210~410 / 260~520 | 低振動/高トルク |
| KV42 | 2 | □42 | 1.8 | ユニポーラ/バイポーラ | 150~295 / 200~390 | 低振動/高トルク |
| KF42 | 2 | □42 | 1.8 | ハイポーラ | 330~460 | 超高トルク |
| KH56 B900 | 2 | □56 | 1.8 | ユニポーラ/バイポーラ | 680~1970 / 780~2270 | 高トルク |
| KH60 B900 | 2 | □60 | 1.8 | ユニポーラ/バイポーラ | 1450~1750 / 1950~2400 | 高トルク |
| KH86 | 2 | □86 | 1.8 | ユニポーラ/バイポーラ | 2500~6700 / 3300~9300 | 高トルク |
| KT35 | 3 | □35 | 1.2 | スター | 59 | 超低振動 |
| | | | 0.6 | スター | 90~200 | 高精度/超低振動 |
| KT42 | 3 | □42 | 1.2 | スター | 70~280 | 超低振動 |
| | | | 3.75 | スター | 55~180 | 高精度/超低振動 |
| | | | 0.6 | スター | 440~600 | 高精度/超低振動 |
| KT60 | 3 | □60 | 1.2 | スター | 600 | 超低振動 |
| | | | 0.6 | スター | 440~600 | 高精度/超低振動 |

Stepper motors



2 Phase/3 Phase Steppers
Bipolar and Unipolar Wiring
24VDC

14.4 ~ 9300 mN·m Holding Torque

KH4248-B901 □ □

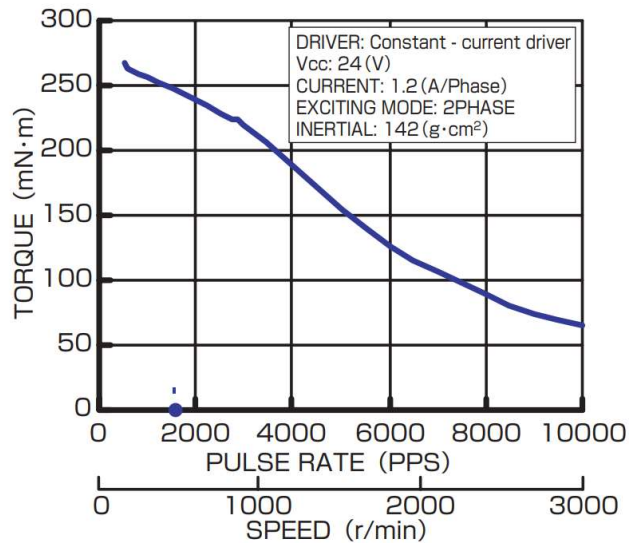

1.8° / step

NEMA 08

KH20 series

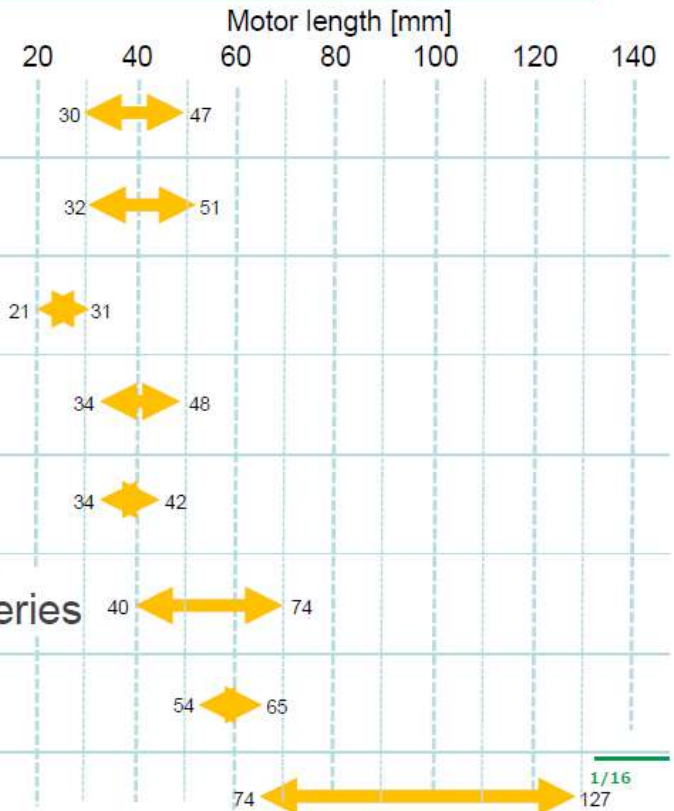

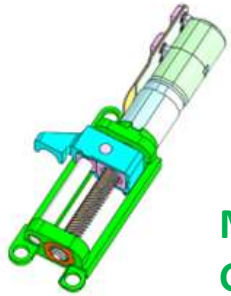

Stepper motors



Microstepping-Geared

Not seen on slide are additional offerings such as Spur-Gear Stepper and RC Module

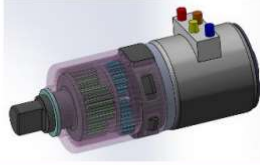

| Motor type | Stepping Geared Motor | |
|-----------------------------|---|---|
| Image |  |  |
| Model | LPD6G-077 | LPD6G-028 |
| Motor body size | Φ6×L12.75 | W7×L12.5 |
| Exciting driving | Bipolar | Bipolar |
| Rated voltage (V) | 5 | 3 |
| Resistance (Ω) | 20±10% | 33±10% |
| Gear Ratio | 1/47.02... | 1/135.7... |
| 1 Step Angle (Motor) | 18° | 18° |
| 1 Step Angle with Gear Head | 0.383° | 0.132° |
| Weight (g) | 1.1 | 1.4 |

Permanent Magnet DC motors



Applications:

Office equipment, game play machines, working machines, money handling machines, agricultural machines, housing equipment, packaging machines, automobiles, bending machines, medical equipment, inspection instruments, etc.

Durable, high-output, and low-noise

- Compact and high-output motors competitive to those with an output a rank above.
- Resin brush holders are used to reduce noise.
- Combined with a variety of gear heads to accommodate various needs.
- Constant operation-based curability: 3,000 hours, 1 million cycles in repetitive operations.

(*Subject to operating conditions.)

| 機種名 | 定格 | | | | | 無負荷 | | 停動トルク mN・m | 対応ギヤヘッド減速比 | |
|---------|---------|---------|-------------|---------|---------------|---------|---------------|---------------|-------------|-------------|
| | 出力 W | 電圧 V | トルク mN・m | 電流 A | 回転速度 r/min | 電流 A | 回転速度 r/min | | ギヤヘッド 付き | ギヤヘッド 別売 |
| DMN29BA | 3 | 12 | 7.8 | 0.42 | 3700 | 0.07 | 5000 | 30 | 9~600 | 3~1800 |
| DMN29BB | 3 | 24 | 7.8 | 0.21 | 3700 | 0.05 | 5000 | 30 | | |
| DMN37SA | 4.6 | 12 | 9.8 | 0.78 | 4500 | 0.26 | 5500 | 54 | 9~72 | |
| DMN37SB | 4.6 | 24 | 9.8 | 0.37 | 4500 | 0.12 | 5500 | 54 | | |
| DMN37BA | 7.2 | 12 | 14.7 | 1.01 | 4700 | 0.25 | 5500 | 98 | | |
| DMN37BB | 7.2 | 24 | 14.7 | 0.53 | 4700 | 0.13 | 5500 | 98 | | |
| DMN37KA | 9.2 | 12 | 24.5 | 1.2 | 3600 | 0.27 | 4300 | 160 | | |
| DMN37KB | 9.2 | 24 | 24.5 | 0.6 | 3600 | 0.14 | 4300 | 160 | | |
| DMN37JB | 14.7 | 24 | 39.2 | 0.94 | 3600 | 0.16 | 4300 | 240 | - | |
| DMN37HB | 27 | 24 | 68.6 | 1.57 | 3800 | 0.14 | 4800 | 340 | | |

Permanent Magnet DC motors



PMDC Motors

DME Series 25 ~ 60 mm OD
DMN Series 29 ~ 37 mm OD
12 ~ 24 VDC

Product Characteristic

- Lower operational time between profile cycles
- No feedback
- Torque and speed have a linearly inverse relationship
- Lower cost
- Brush wear

Additional catalog offerings available in Nidec Precision Catalog

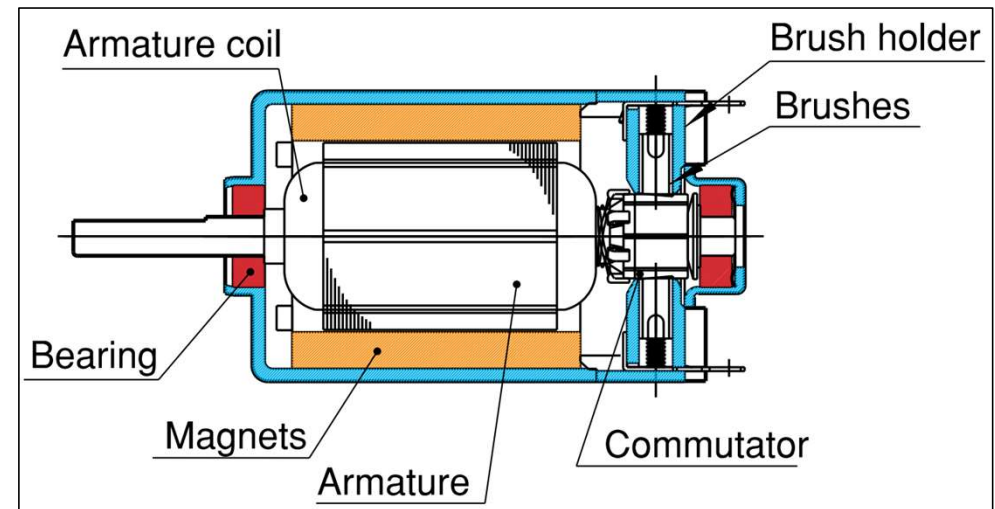
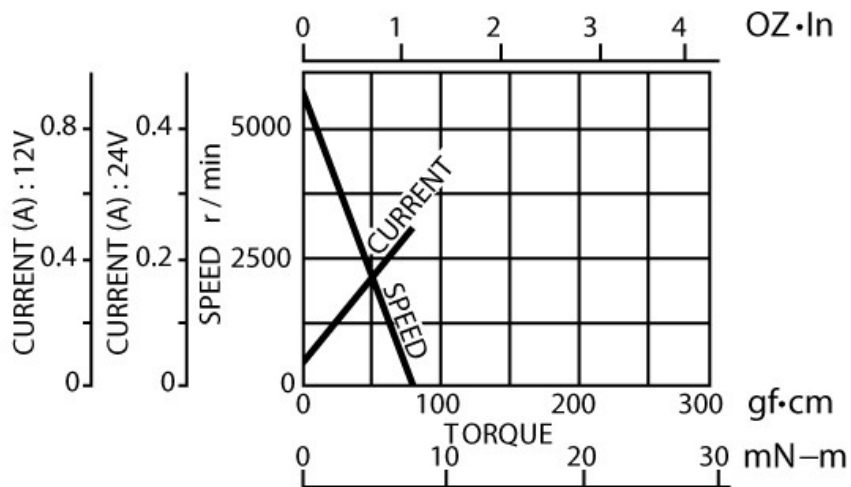

Elinco International JPC

Brushless DC fans



Axial Cooling Fans

- Low noise
- Low vibration
- High static pressure

Frame Dimensions : □40~Φ172
Airflow: 12 ~ 501 CFM

Sizing Considerations

- Maximum Static Pressure
- Maximum Airflow
- Frame Dimensions and Thickness
- Audible Noise
- PWM or Signal Output requirements
- Power Supply Voltage
- Maximum Fan Current or Voltage
- IP Rating
- Series or Parallel Configuration Compatible

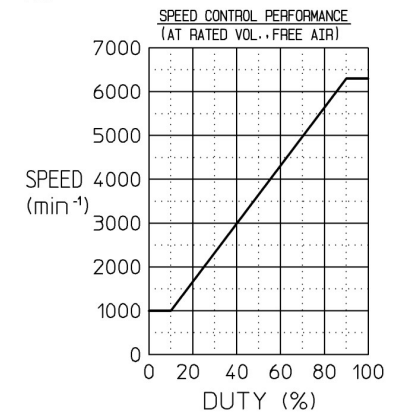
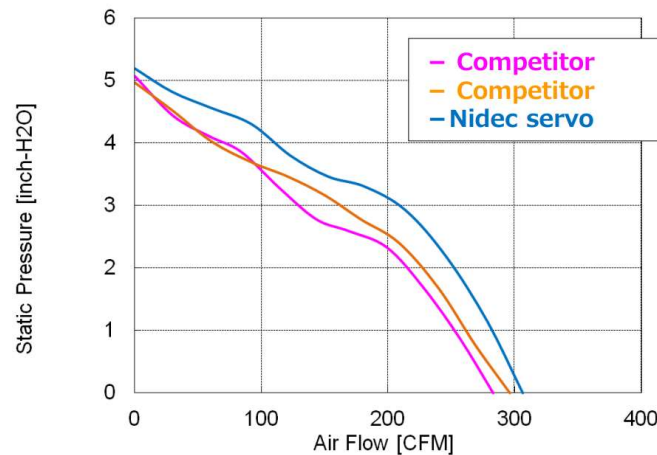

Brushless DC fans

Compact Axial Fans

17 ~ 60 mm Frame Size
 Rated Voltage 3.3, 5, 12 VDC
 Airflow 0.212 ~ 11.3 CFM



Applications

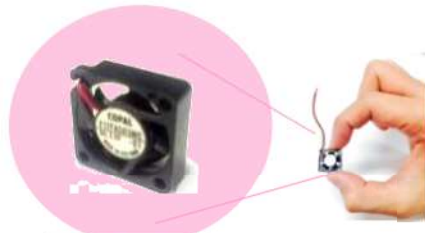

F17FA
 (□17 x 5mm)

| Size | 5mm | 8mm | 10mm | 15mm | 25mm | 32mm | 38mm | 50mm | 51mm |
|-------|------|------|------|------|------|------|------|------|------|
| φ 172 | | | | | | | | | NAMC |
| □130 | | | | | | | | NAMC | |
| □120 | | | | | NAMC | | NAMC | | |
| □92 | | | | | | NAMC | NAMC | | |
| □80 | | | | | NAMC | | | | |
| □70 | | | | | | | | | |
| □60 | | | | NPCJ | NAMC | | NAMC | | |
| □40 | | | NPCJ | | | | | | |
| □30 | | | NPCJ | | | | | | |
| □25 | | | NPCJ | | | | | | |
| □17 | NPCJ | NPCJ | | | | | | | |

Fan thickness in comparison to NAMC subsidiary catalog



Low-noise, energy-efficient, a wide variety of product lineup

- DC drive blowers that feeds air to the distal direction
- High static pressure efficiency
- Blades' design: Unsteady flow analysis to minimize the blades' air vortex to reduce noise

Applications:

Office machines, appliances, servers and routers, mobile phone base stations, automobiles, beverage machines, image projectors, housing and building equipment, power source cooling, construction equipment, etc.

| シリーズ名 | フレーム外形寸法(mm) | | 最大風量 (m ³ /min) | 最大静圧 (Pa) |
|----------|--------------|----|----------------------------|-----------|
| | サイズ | 厚み | | |
| E0525H/K | □48 × | 25 | 0.22 | 220 |
| E0515 | 51 × 53 | 15 | 0.1-0.12 | 135-210 |
| E0720H | 70 × 76 | 20 | 0.25-0.29 | 210-300 |
| E0720L | 72 × 75 | 20 | 0.31 | 265 |
| SMBD | □76 × | 25 | 0.24-0.33 | 88-180 |
| MBDC | | 30 | 0.25-0.33 | 83-172 |
| SFBD | □94 × | 30 | 0.44-0.65 | 120-280 |
| E1027H | 97 × 95 | 25 | 0.57-0.78 | 315-520 |
| E1033H | | 33 | 0.53-1.14 | 120-500 |
| E1033L | | 33 | 1.15-1.55 | 700-1400 |
| E1232L | 119 × 117 | 32 | 0.75-1.13 | 200-460 |
| E1331K | 126 × 127 | 31 | 0.72-1.08 | 210-480 |
| E1540H | 150 × 152 | 40 | 1.65-2.0 | 270-430 |
| E2271Z | Φ220 × | 71 | 14.7-18.1 | 470-600 |

Brushless DC Blowers



Blower Fans

- Low noise
- Multi-blade Impeller
- High Air Flow

Frame Dimensions : □48~Φ220
Airflow: 7.8 ~ 639 CFM



Sizing Considerations

- Maximum Static Pressure
- Maximum Airflow
- Frame Dimensions and Thickness
- Audible Noise
- PWM or Signal Output requirements
- Power Supply Voltage
- Maximum Fan Current or Voltage
- IP Rating
- Series or Parallel Configuration Compatible

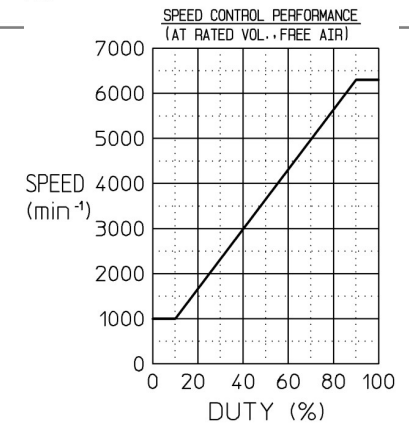
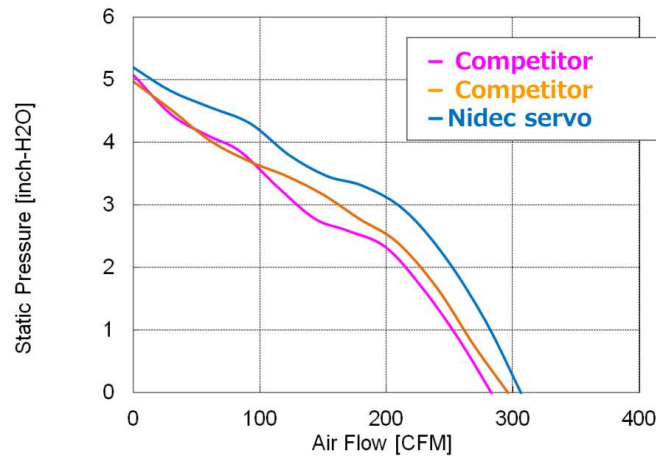

LRA/ ERM “Haptic” output motors



“Haptic” output motors

Applications



| Motor type | Linear Resonant Actuator (LRA) | | | |
|-----------------------------|--------------------------------|--------------------------|-----------------|-----------------|
| | Sprinter Z | Sprinter F | Sprinter γ | Deus2 |
| Image Movement direction | | | | |
| Dimension (W×L×H) | 4×12×3.5 mm | 6×12×2.8 mm | 8×15×3.8 mm | 9×20×3.0 mm |
| Rated Voltage | AC 1.8 Vrms | AC 2.0 Vrms | AC 2.0 Vrms | AC 2.0 Vrms |
| Frequency | 240 Hz | 190 Hz | 150 Hz | 180 Hz |
| Acceleration@F0 | 0.9 Grms(min) | 1.2 Grms(min) | 2.0 Grms(min) | 3.7 Grms(min) |
| Rise time (0-50%) | 50 ms(max) | 50 ms(max) | 50 ms(max) | 40 ms(max) |
| Fall time (100-50%) | 80 ms(max) | 55 ms(max) | 50 ms(max) | 40 ms(max) |
| Rated current | 90 mA(max) | 150 mA(max) | 160 mA(max) | 230 mA(max) |
| Resistance | 25.9 Ω | 13.6 Ω | 14.0 Ω | 10.8 Ω |
| Production Status | Mass-production | Under development | Mass-production | Mass-production |

Elinco International JPC

LRA/ ERM “Haptic” output motors

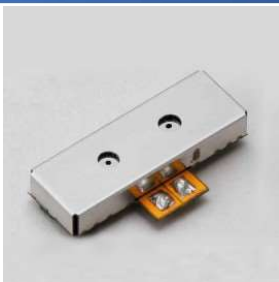

LRA/ERM





Applications



Click!



Vibration Motor – Brushed Cylinder Type (ERM)

| Motor Type | Cylinder Type | | | |
|---|--|---|---|---|
| | Non-SMD | | | SMD |
| Image | LA3R5-472QC | LA4-459QB | LA4-473KB | BRE-3728 |
| |  |  |  |  |
| Motor body size W/L/H | Φ3.5×L8 4.1/13.5/4.35 | Φ4×L8 5.0/13.35/5.8 | Φ4×L8 4.7/13.0/4.7 | Φ4×H3 L6 4.4 / 11.4 / 3.4 |
| Rated voltage (V) | 3.0 | 3.0 | 3.0 | 2.7 |
| Rated speed (rpm) | 11,500±2,500 | 10,000±3,000 | 8,000±3,000 | 14,000±2,500 |
| Rated current (mA) Typ. | 60 | 82 | 110 | 68 |
| Stall current (mA) Typ. | 73 | 96 | 134 | 77 |
| Counter weight size | R2.0-L3.0 | R2.5-L3.6 | R3.0-L3.6 | R1.7 L2.8 |
| ※Ref. Vibration (G _{0-p}) | 100g Block | 0.68 | 0.83 | 1.22 |
| | 50g Block | 1.36 | 1.66 | 2.44 |

Elinco International JPC

CUSTOMIZE

Elinco - JPC offers fast solutions on Mechanical, Electrical, and Metal design. Utilize Customization and Value Add Capability.

Improve Performance | Quality per ISO and Six Sigma | Special Documentation
Save Time | Supply Chain Control

VALUE ADDED SERVICES

Elinco - JPC value-added services offers our strong capability to manufacture motors specific to your environmental, mechanical, and dimensional requirements.

Value Added Services for Motors such as pulley and coupling installation, encoders, gearboxes, special shafts, dampers and more.

ENCODERS



Verification & Accuracy with Encoders

VIBRATION



Resonance & Vibration with Dampers

GEARBOXES



Precision Gearbox Options

CUSTOMIZED BOARD DESIGN



Intelligent Motors with Electronic Design

SHAFT OPTIONS



Many shaft options easily and quickly configured

CUSTOM HOUSINGS



End Bell Design

CUSTOMIZED WINDINGS



Semi-Custom or Custom

ACTIVE MATERIAL ANALYSIS

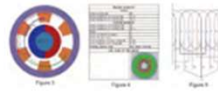

Software Analytics Neodymium, Ferrite, or FCC Magnets

THERMAL ANALYSIS

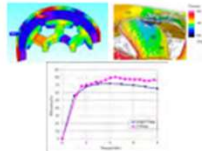

Metals and Plastics

ENVIRONMENTAL PROTECTION

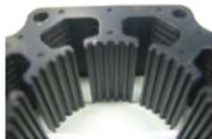

Standard Coating, E-Coating, Various IP

BEARINGS



Bearings

WIRE HARNESS ASSEMBLY



Special Lead wires and Connectors

ELECTROMECHANICAL SUB-ASSEMBLIES

From Prototype to Production Elinco - JPC is your Single-Source Supplier for Contract Manufacturing and Electromechanical Subassembly requirements. Our custom engineered OEM solutions utilize expertise in process controls of precision components, gearing, assembly, testing, precision motion control build to print as well as best practices. Factories in Asia and the US are ISO certified.

OUR CORE STRENGTHS ARE:

- Contract Manufacturing – Motion Control Assemblies
- Precision positioning and motion systems
- Fine-pitch, custom, and standard gearing experts to AGMA standards
- Specialists in gears, bearings, motors, precision assemblies
- Unique engineered solutions from initial design to production
- Manufacturing excellence and ultimate quality
- DFMEA, PFMEA, FAI, PPAP, Control Plan
- Reliability in design, and total partnership with our customers
- Vertically Integrated Manufacturing
- Manufacturing and Assembly of small to large Motion Control and Electro-Mechanical Assemblies

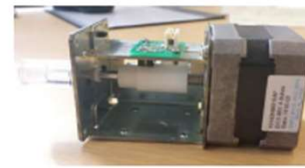

INTERNATIONAL STANDARDS ON MEDICAL ASSEMBLIES

- ISO 13485(MDD) Management system for medical devices
- IEC 60601-1-1 Medical equipment and electrical equipment
- IEC 60601-1-2 Electromagnetic compatibility for medical devices
- IEC 60601-2-24 Safety of infusion pumps and controllers
- ISO 14971 Application of risk management to medical devices
- IEC 62304 Medical device software - software life cycle processes

Gears - Pulleys - Lead Screws – Holes – Slots – Chamfers - Drill and Pin – Flats – Threads - Fan Trays
Encoder Mounting- US Digital partner, CUI partner - Balancing, Testing



Elinco International JPC – Design and Manufacturing

Design capabilities

FEA

- Magnetic
- Mechanical

Solid modeling design

Custom MatLab Simulink blocks for
system design modeling

Failure mode analysis

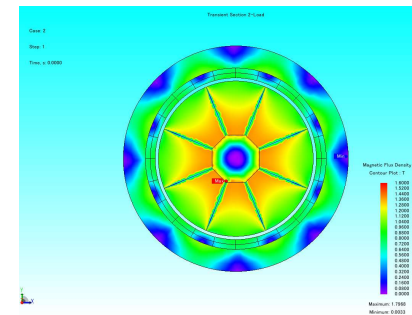

Build capabilities

Highly custom to stock part

ISO 9001 facility

Unmatched quality

Strong US, and friendly nation-based supply chain to ensure
business continuity for our US based production facility

ISO 9001:2015 Certified

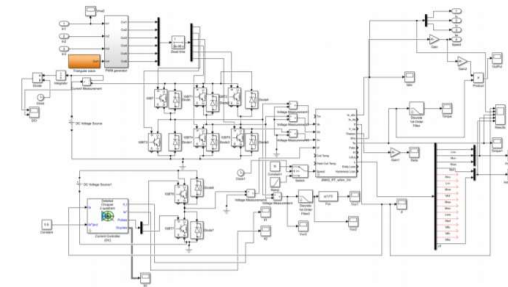

Elinco International JPC

Manufacturing

- Production facility in Fairfield CT or Contract Manufacturing available in Asia.
- Localized production for US customer base.
- Worldwide sourcing and tariff minimization.
- Cellular manufacturing setup
 - Allows for efficient build and a high degree of flexibility to customize the manufacturing process to meet the customer build requirements.
- Semi-automation
 - Automation in labor intensive task to reduce costs.
- Skilled labor force
 - Maximize the advantage of our automation.

Test



Coordinate Measuring

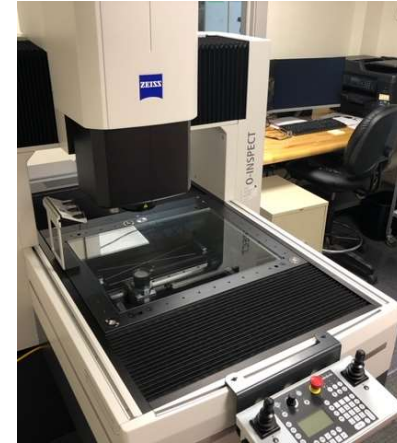

Balancing



Elinco International JPC

Elinco International JPC – Quality

- ISO9001 2015 Certified QMS System
- Focused on consistently meeting customer requirements and enhancing satisfaction.
- Processes are designed to meet necessary statutory and regulatory requirements.
- Helps to anticipate future needs of our customers.
- Able to provide qualified product/PPAP



Nidec Advanced Motors Corporation



| R&D center | Sales office | Factories |
|----------------------------|-------------------------------|-------------------------------|
| 1 (Gunma, Japan) | 8 (Japan & Oversea) | 5 (Japan & Oversea) |



Nidec Precision Corporation



Major Bases in Asia (Outside Japan)



※Overseas sales offices are integrated with Nidec

- Nidec (Beijing · Shenzhen) Co., Ltd.
- Nidec Precision (Shanghai) Co., Ltd (China Development Center)
- Nidec Korea Corporation
- Nidec (Shanghai) Int'l Trading Co. Ltd.
- Nidec Taiwan Corporation

Founded in Aug., 1999
Manufacturing of
Shutters and Lens
Units for Cameras and
Mobile Equipment,
Precision Mini-motors



■ Nidec Precision Components
(Thailand) Co., Ltd.

Land area : 51,200m²
Building area : 40,000m²



Land area: 51,480m²
Building area: 29,250m²

■ Nidec Precision Components
(Zhejiang) Co., Ltd.

Founded in Sep., 2001
Manufacturing of Camera Shutters,
Camera Lens Cones, Press Stamping
Parts, Molding Parts, Machining Parts,
Surface Treatment Parts

Founded in Apr.,
2010
Manufacturing of
Precision Mini-
motors



■ Nidec Precision Vietnam Corporation

Land area: 68,200m² / Building area: 48,000m²

● Nidec Precision
(Hong Kong) Co., Ltd.



■ Production Bases

● Sales Offices

■ Tan Thuan Branch of Nidec Precision Vietnam

Land area: 13,742m² / Building area: 10,270m²

- Nidec Europe Sales B.V.
- Nidec Motors & Actuators (Germany) GmbH
- Nidec America Corporation

The logo consists of a thick, curved line that starts on the left, curves upwards and then downwards to the right, ending in a small arrowhead pointing towards the text.

Elinco International JPC

Precision Rotating Components

1525 Kings Highway East
Fairfield, CT 06824
Phone: 203.334.7537
Fax: 203.334.7792
Email: info@e-jpc.com

Website: www.e-jpc.com
ISO 9001:2015 CERTIFIED